

P25-RF-POWER-X-230V

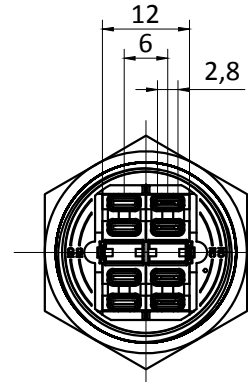
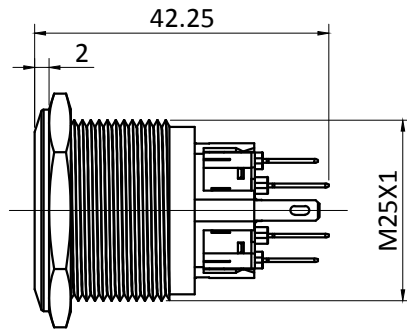
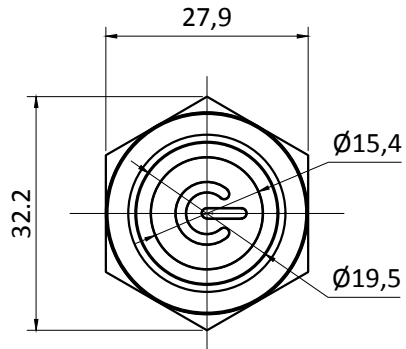

Rating / Schalteistung: 3A 250VAC
 Contact Resistance / Kontaktwiderstand: 50mΩ MAX
 Insulation Resistance / Isolationswiderstand: 100Ω min at 500VDC
 Dielectric Strength / Spannungsfestigkeit: 1000VAC rms.
 Electrical Life / Elektronische Lebensdauer: 100,000 Operations
 Operating Temperature / Betriebstemperatur: -25 °C - +55 °C
 Operating Pressure / Betätigungsdruck: 2 N ~ 5 N
 Operating Stroke / Hub: 1.0mm ~ 6.0mm
 Protection Grade / Schutzklasse: IP67
 Soldering / Löttemperatur: 300°C max. for 5 seconds
 Function / Funktion: OFF (ON)

Material:

Body / Gehäuse: Stainless Steel 304

Button / Drucktaste: Stainless Steel 316

Terminal / Anschluss: Wiring Terminal

Lampenart /	Lamp Type	LED lamp (AC)
Nennspannung /	Rated Voltage	230VAC
LED Farbe /	LED Color	R G Y B W
Lebensdauer /	Life	40000hours
Schaltbild /	Lamp Circuit Diagram	

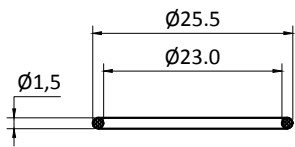

“O”RING

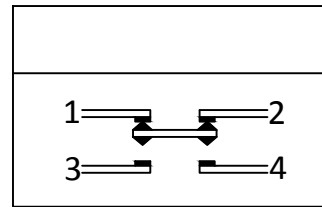

Kontaktart

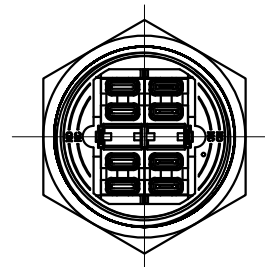

Schaltkreis

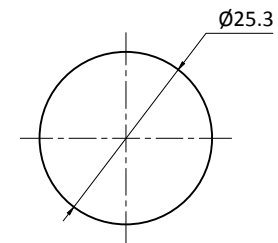

Install size / Bohrbild
